

# Dialog 4223 Professional

System Telephones for MD110 Communication System

*D3 Mode*

Up to and including version BC12.1

User Guide



EN/LZT 103 61 R2B

© Ericsson Enterprise AB 2004

# Table of Contents

Welcome .....	4
Description .....	6
Free Seating (optional) .....	17
Incoming Calls .....	18
Outgoing Calls .....	22
During Calls .....	38
Call Metering .....	44
Call Forwarding .....	46
Absence Information (optional) .....	58
Messages .....	60
Group Features .....	66
Other Useful Features .....	69
Settings .....	77
Accessories .....	90
Installation .....	96
Troubleshooting .....	105
Glossary .....	106
Index .....	107

# Welcome

Welcome to the user guide for the *Dialog 4223 Professional* system telephone in the Ericsson MD110 Communication System, **D3 mode**. It is a state-of-the-art business communications system. Its alliance of features and facilities effectively improves communications for virtually any kind of organization.

There is a line of telephones designed for easy use in every situation to take full advantage of these advanced features and facilities.

Function descriptions that do not include speaking in the handset, are described off hook, if nothing else is stated. Instead of pressing the Clear key, you can always replace the handset.

Some markets use differing codes for some functions. In this guide, all functions are described using the most common code.

The user guide describes the facilities of the *Dialog 4223 Professional* system telephone as it is programmed at delivery from the factory. There may be some differences in the way your phone is programmed. Please consult your system administrator if you need further information.

The latest version of this user guide can also be downloaded from: <http://www.ericsson.com/enterprise/library/manuals.shtml>

**Note:** *Dialog 4223 Professional is a system telephone, i.e. it can only be used for an Ericsson private branch exchange that supports this type of phone.*

## Copyright

All rights reserved. No parts of this publication may be reproduced, stored in retrieval systems, or transmitted in any form or by any means, electronic, mechanical, photocopying, recording or otherwise, without prior written permission of the publisher except in accordance with the following terms.

When this publication is made available on Ericsson media, Ericsson gives its consent to downloading and printing copies of the content provided in this file only for private use and not for redistribution. No parts of this publication may be subject to alteration, modification or commercial use. Ericsson will not be liable for any damages arising from use of an illegal modified or altered publication.

---

## Warranty

ERICSSON MAKES NO WARRANTY OF ANY KIND WITH REGARD TO THIS MATERIAL, INCLUDING, BUT NOT LIMITED TO, THE IMPLIED WARRANTIES OF MERCHANTABILITY AND FITNESS FOR A PARTICULAR PURPOSE. Ericsson shall not be liable for errors contained herein nor for incidental or consequential damages in connection with the furnishing, performance or use of this material.

---

## Declaration of conformity

*Hereby, Ericsson Enterprise AB, declares that this telephone, is in conformity with the essential requirements and other relevant provisions of the European R&TTE directive 1999/5/EC.*

Details to be found at: <http://www.ericsson.com/sdoc>.



# Description

## Dialog 4223 Professional phone

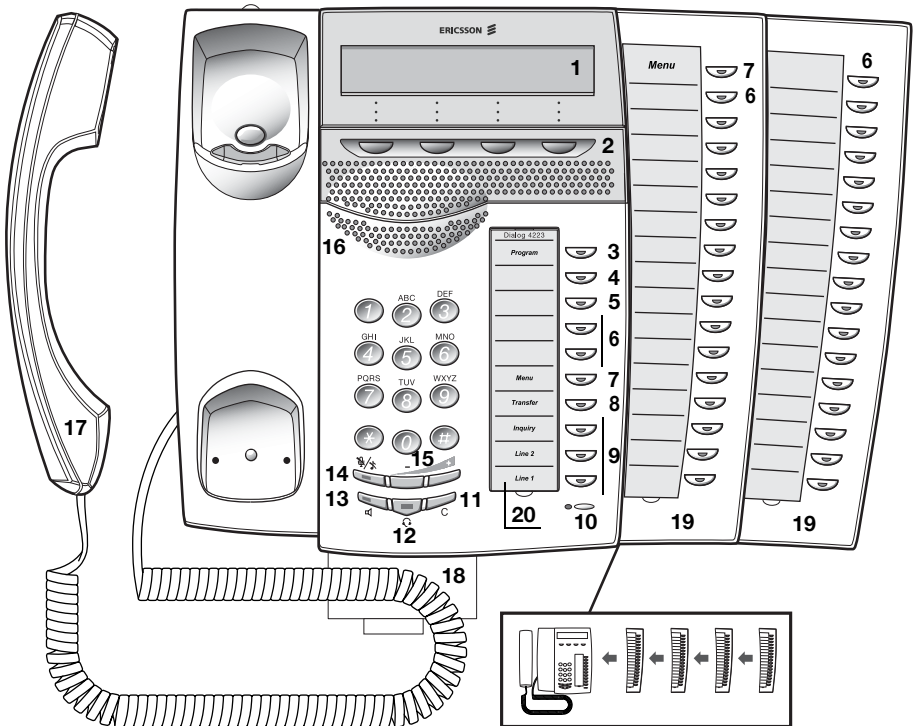

- 1 Display**  
3x40 characters. See section “[Display information](#)” on page 13.
- 2 Menu Function keys**  
The functions depend on the traffic state. When you are requested to “(see display)”, press the required key to access the function. See also “Menu key”.
- 3 Programming**  
See section “[Settings](#)” on page 77.

- 4 Callback**  
For indicating/activating Callback. See section “[When you receive a busy tone](#)” on page 26. The feature can be removed or moved to another programmable Function key by your system administrator.
- 5 Diversion (Follow-me)**  
For indicating/activating and deactivating Diversion (Follow-me). See section “[Call Forwarding](#)” on page 46. The feature can be removed or moved to another programmable Function key by your system administrator.
- 6 Programmable Function keys**  
To program numbers or functions, see section “[Programming of Function keys](#)” on page 77. All key panel keys are programmable (except the Menu key).
- 7 Menu key**  
When the phone is in idle mode, press to switch between “idle display” and Menu Function key descriptions.  
  
***Note:** Depending on the system version, the key position differs. To find the Menu key for your system, look for display reactions when you press any of the two keys. The key press that changes the text of the Menu Function keys, is the key to be used. The other key can be used as a programmable key.*
- 8 Transfer**  
For transferring calls, see section “[During Calls](#)” on page 38.
- 9 Triple Access Line**  
For handling calls. Line 1 and 2 are available both for incoming and outgoing calls. Inquiry can only be used for outgoing calls.
- 10 Microphone**  
Used for handsfree conversation.
- 11 Clear**  
To disconnect calls or exit a function. Can always be pressed instead of replacing the handset.
- 12 Headset key**  
To handle headset calls and activate Headset Preset. See section “[Headset \(optional\)](#)” on page 91.

**13 Loudspeaker on/off**

- a. To activate Group Listening. See section “[During Calls](#)” on page 38.
- b. To activate handsfree conversation. See section “[During Calls](#)” on page 38.
- c. To activate Loudspeaker Preset. See section “[Headset Preset](#)” on page 92.

**14 Mute**

- a. To switch the microphone on or off during a call. See section “[Mute](#)” on page 39.
- b. To switch off the ring signal in idle mode or when ringing. See sections “[Mute ring signal](#)” on page 84 and “[Silent Ringing](#)” on page 84.

**15 Volume control**

To change the volume. See section “[Settings](#)” on page 77.

**16 Loudspeaker**

**17 Handset**

Supplied with hearing aid function as standard. An extra handset can be connected, see section “[Accessories](#)” on page 90.

**Please note:** *The handset may attract and retain small metal objects in the earcap region.*

**18 Pull-out leaf for easy guide (optional)**

See section “[Pull-out leaf \(optional\)](#)” on page 94.

**19 Key panel**

With 17 programmable keys. Up to four panels can be connected. See section “[Key panel](#)” on page 90. Use the Designation Card Manager to make and print your own key panel designation cards, see below.

**Notes:**

*Depending on the system version, the Dialog 4223 Professional phone can be delivered with one key panel as standard.*

*The possible number of key panels is system version dependent.*



## 20 Designation card

Use the DCM (Designation Card Manager) to make and print your own designation cards. DCM is included on the Enterprise Telephone Toolbox CD or it can be downloaded from: <http://www.ericsson.com/enterprise/library/manuals.shtml>

For more information, please contact your Ericsson Enterprise certified sales partner.

---

## D3 mode information

The Dialog 4223 Professional phone can be connected to the exchange in two different modes (user interfaces), either D3 mode, or D4 mode. There is one user guide for each mode.

To find out the mode for your telephone, check the right hand side of the second row of the display (see picture), when the telephone is in idle mode:

- Extension number is shown - your telephone is using D3 mode = This is the correct guide.
- No extension number is shown (i.e. blank) - your telephone is using D4 mode = This is not the correct guide, download the user guide from: <http://www.ericsson.com/enterprise/library/manuals.shtml>

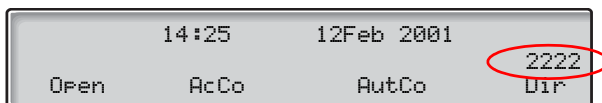

**Note:** This user guide is not valid for the Dialog 4223 Professional in D4 mode.

## Lamp indications



Extinguished lamp

The function is not active.



Steady light

The function is active or multiple represented line is busy.



Slowly flashing lamp

The line (or function) is put on hold.



Rapidly flashing lamp

An incoming call.



Light with short breaks











Ongoing call.

## Tones and signals

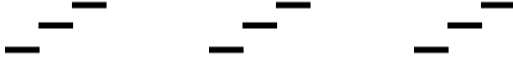
The following different tones and signals are sent from the exchange to your phone.

### Tone characteristics

The tones shown in this section are the most used tones worldwide. Many markets use a differing tone for one or more situations.

Dial tone	
Special dial tone	
Ringing tone or queue tone	
Busy tone	
Congestion tone	
Number unobtainable tone	
Call waiting tone	
Intrusion tone	
Conference tone	
Verification tone	
Warning tone, expensive route	

**Ring signals**

Three different ring signals inform you about the type of the incoming call. The signals shown in this section are the most used signals worldwide. Many markets use signals that are adapted for the local standards. If you get a signal that is not described or you cannot identify, ask your system administrator.

Internal ring signal



External ring signal



Recall signal  
(Callback reminder)



## Display information

The display gives you feedback information such as time and date, traffic state and connected phone numbers. The following displays show examples of the different states your phone is in.

When an information ends with three dots (...), this means that the system is working or waiting for your action. When an information ends with an exclamation mark (!), this means that no further action is possible.

**Note:** *The order in which the date is stated is system dependent.*

### Idle phone

When your phone is idle, the upper row shows general information. The middle row shows your extension number. The lower row presents lead texts for the menu Function keys.

	14:25	12Feb 2001	
Open	AcCo	AutCo	2222 Dir

### Outgoing call

When you make an outgoing call on your phone, the middle row shows both the traffic state and dialed number.

	14:25	12Feb 2001	
Calling...			3333
CBack			Time

If the called party's phone is diverted, the middle row shows the Diversion information. > is the Diversion symbol.

	14:25	12Feb 2001	
	3333 >Direct		5555
CBack			Time

The dialed number (3333) is directly diverted to number 5555.

**Incoming call**

When you receive an incoming call, the middle row flashes the calling party's extension number.

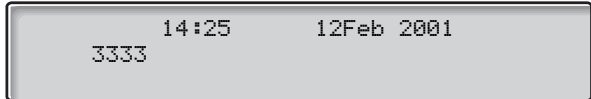

If a diverting extension is calling, the middle row shows the Diversion information. The calling party's number is flashing. > is the Diversion symbol.

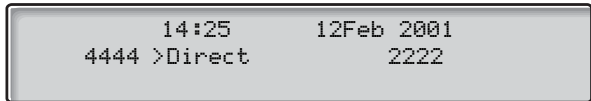

Number 2222 has dialed number 4444 and the call is directly diverted to you.

### **Menu Function keys**

The menu Function keys are used to access different functions. Depending on which traffic state and category of extension, the available functions change.

The following abbreviations are used for the menu Function keys:

AcCo	Account Code
AutCo	Authorization Code
Call	Call the number displayed
CBack	Callback
Clr	Reset time measurement
Conf	Conference (only shown when there is a party put on hold)
Cost	Display cost information
CUF	Group call pick-up
CWait	Call Waiting
Date	Show date
Del	Delete
DND	Do Not Disturb
Down	Scroll down
Exit	Exit the displayed menu
Find	Search
Intr	Intrusion
Lock	Lock the phone
Mal	Malicious Call Tracing
Next	Show next logged number
Open	Unlock the phone
Pase	Paging
Pick	Call pick-up
RDial	Last Number Redial
Space	Enter a space when writing names
Start/Stop	Start/Stop time measurement
Time	Display time measurement
Tones	Dialing during a connected call (Push button tones, DTMF)
UF	Scroll up

**Choice of language (optional)**

One of the following languages can be chosen to be used for the display information on your phone.

Digit 0-9 = the language code:

0 English    1 French    2 German    3 Spanish    4 Italian  
5 \_\_\_\_\_ 6 \_\_\_\_\_ 7 \_\_\_\_\_ 8 \_\_\_\_\_ 9 \_\_\_\_\_

**Note:** *By default 5-9 are programmed for English. To be changed locally to other languages.*

To choose a language:

**\*08\***

**Dial.**

**(0-9)**

**Enter the language code.**

# 

**Press.**



## Free Seating (optional)

The Free Seating function is used for persons who have an office extension number but no phone set of their own. For example, flexible office workers, persons mostly working outside the office, etc. As a Free Seating user and working from the office, you logon to any free phone set that temporarily will be assigned with your extension number and your system authorities.

### To log on

**\* 1 1 \***

**Dial.**

⊙ ⊙ ⊙  
⊙ ⊙ ⊙ ⊙ \*  
⊙ ⊙ ⊙ ⊙  
⊙

**Enter the Authorization Code and press.**

⊙ ⊙ ⊙ ⊙  
⊙ ⊙ ⊙ ⊙ #  
⊙ ⊙ ⊙ ⊙  
⊙

**Enter your phone number and press.**



**Press to finish the procedure.**

The display shows your phone number.

### To log off

**# 1 1 #**

**Dial.**



**Press to finish the procedure.**

# Incoming Calls

## Answer calls

A ring signal and a flashing lamp indicate an incoming call.

### On Line 1

Normally you will receive calls on Line 1.



**Lift the handset.**

### On any other Line key

**Lift the handset.**



**Press the flashing Line key.**

### Handsfree



**Press the flashing Line key.**

You are connected to the caller via the loudspeaker and the microphone.



**Press to terminate a handsfree call.**



### On another extension

You can answer a call to a phone in another room:

#### Call the ringing extension.

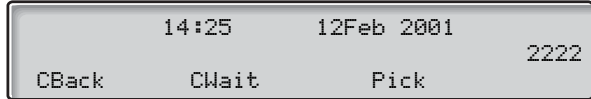

**Note:** The display image might differ from the above.

## 8 Press.

#### **Notes:**

You can also press **Pick** (see display) or *On hold/Pick-up* (Function key preprogrammed by you).

France, press **4**; Sweden, press **6**

## Answer a second call during an ongoing call

If your phone is preprogrammed with a Free on 2nd key, you can receive another call, if this function is activated.

Free on 2nd 

### Press to activate/deactivate.

When Free on 2nd is active the lamp is on.

**Note:** *Function key preprogrammed by your system administrator.*

You have an ongoing call on Line 1, when Line 2 flashes to indicate a new incoming call:

Line 2 

### Press to answer.

The first call is put on hold.

Line 1 

### Press to switch back to the first call.

The second call is put on hold. You are connected to the first caller.



### Press to terminate the connected call.

**Note:** *If the calling party has activated Call Waiting, you can receive a second call even if Free on 2nd is not activated.*

## Call Waiting

If the calling party has activated Call Waiting, you can receive a second call even if Free on 2nd is not activated.

To answer the waiting call:



### Press to terminate the connected call.

Your phone will ring to announce the waiting call.

Line 

### Press the flashing Line key to receive the new call.

## Do Not Disturb, DND

When you activate DND, calls to your extension are not indicated. Outgoing calls can be made as usual.

**DND**

**Press to activate or deactivate DND (see display).**

**Note:** You can also press DND (Function key preprogrammed by your system administrator) or use the procedure below.

**\*27#**

**Dial to activate,**  
Special dial tone.

**or**

**#27#**

**dial to deactivate.**



**Press to finish activation/deactivation.**

**Note:** If your phone is programmed with "Multiple Directory Diversion and Do Not Disturb" (ask your system administrator), DND is ordered and cancelled simultaneously on all lines. This function is only available in newer versions of the telephone exchange.

# Outgoing Calls

## Make calls

How to make internal and external calls:



**Lift the handset and proceed depending on call type:**

### Internal calls



**Dial the extension number.**

### External calls

**0**

**Press the digit or digits to get an external line.**

Dial tone.

**Note:** *The particular digit or digits used in your office, e.g. 0 or 00.*



**Dial the external number.**

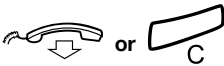

**Replace the handset or press to end the call.**

**Note:** *If you receive a queue tone when the digit or digits to get an external line are dialed (optional function Least Cost Routing is used in the system), keep waiting. Once a line becomes free you will receive a dial tone. If a warning tone is heard, the selected line is marked "Expensive".*



### Handsfree

With the handset on hook:

#### **Dial the number.**

You are connected via the loudspeaker and the microphone.

#### **Press to terminate a handsfree call.**

**Note:** You can make your calls faster by using common Speed Dialing numbers and by using your own programmed Function keys. See section “Speed Dialing” on page 30.

## Number Presentation Restriction

If you do not want your name and number to be displayed to the person you are calling, use the following procedure.

#### **Notes:**

*This function is only available in newer versions of the exchange, and it might be blocked for use on your extension (programmed by your system administrator).*

*The Number Presentation Restriction is only valid for the ongoing call, i.e. the procedure has to be repeated the next time you want to use it.*

**\* 4 2 #**



#### **Dial and wait for a new dial tone.**

#### **Dial the number.**

Instead of your name and number, the display on the called phone shows **Anonymous**.

## Individual External Line

To make a call on a specific external line:

**\* 0 \***

**Dial.**

 **#**

**Dial the Individual External Line number and press.**



**Dial the digit or digits to get an external line and the external number.**

---

## Last External Number Redial

When you initiate an external call the system automatically stores all the dialed digits, irrespective of whether the call was successful or not.



**Lift the handset.**

**\* \* \***

**Dial to repeat the stored number.**

The last external number is automatically redialed.

**Notes:**

*You can also press **Redial** (see display) or Last Number Redial (Function key preprogrammed by you).*

*Finland and Sweden, dial **\* \* 0***



## Save external number

When you make an external call, you can save the number in order to redial the same number easily. Any previously saved number is erased.

To save an external number:



**Press before you finish the call.**

**Note:** *Function key preprogrammed by your system administrator.*

### Redial number



**Lift the handset.**

**Press to redial the number.**

**Note:** *Function key preprogrammed by your system administrator.*

## When you receive a busy tone

If you call an extension and receive a busy tone, or get no answer, or all external lines are busy, you can use any of the following methods:

### Callback

If a called extension is busy or there is no answer:

#### **6 Press.**

**Notes:**

*You can also press: **CB**ack (see display) or **Callback** (Function key preprogrammed by you).*

*France, Finland and Sweden, press **5***



**Replace the handset to finish procedure.**

You are called back (recall ring signal) when the ongoing call is finished or the next time a new call is finished. You have to answer within eight seconds, otherwise the Callback service is cancelled. While waiting for the Callback, you can make and receive calls as usual.



**Lift the handset when you are called back.**

The system calls the extension.

**Note:** *Callbacks can be activated on several extensions at the same time. Callbacks from additional lines will recall on Line 1.*

If all external lines are busy (after dialing the digit or digits to get a line):

**6 Press.**

**Notes:**

You can also press: **CB**ack (see display) or *Callback* (Function key preprogrammed by you).

*France, Finland and Sweden, press 5*



**Dial the external number and press.**

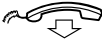

**Replace the handset to finish procedure.**

When an external line becomes free you will be called back (recall ring signal). You have to answer within eight seconds, otherwise the Callback service is cancelled. While waiting for the Callback, you can make and receive calls as usual.



**Lift the handset when you are called back.**

The system calls the external number.

**Note:** Only one Callback can be activated on a busy external line. Callbacks from additional lines will recall on Line 1.

**Cancel any single Callback**

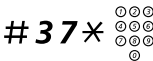

**Dial and enter the extension number.**

**Note:** To cancel a single Callback on a specific external line, dial the digit or digits to get a line instead of the extension number.



**Press.**

**Cancel all Callbacks**



**Dial.**



**Press.**

### **Activate Call Waiting**

If you urgently wish to contact a busy extension or external line, you can notify by a Call Waiting signal.

#### **5 Press.**

**Notes:**

You can also press: **Clwait** (see display) or Call Waiting (Function key preprogrammed by you).

France and Finland, press **6**; Sweden, press **4**

Keep handset off hook. When the called extension or the external line becomes free, it will be called automatically.

**Note:** The Call Waiting function might be blocked for use on your extension (programmed by your system administrator). If Call Waiting is not allowed you will continue to receive a busy tone.

### **Intrusion on a busy extension**

You can intrude on an ongoing call on a busy extension.

#### **4 Press.**

**Notes:**

You can also press: **Intr** (see display) or Intrusion (Function key preprogrammed by you).

France and Sweden, press **8**

Before the Intrusion is executed a warning tone is sent to the parties in the ongoing call. A three party call is established and a warning tone is heard.

**Note:** The warning tone might be disabled for your system. The Intrusion function might be blocked for use on your extension (programmed by your system administrator). If Intrusion is not allowed, you will continue to receive a busy tone.

**Intrusion on a busy external line**

You can intrude on an ongoing call on a busy external line.

**\* 4 4 \*** 

**Dial and enter the Individual External Line number.**

**#** 

**Press and dial the digit or digits to get an external line.**  
Busy tone.

**4** **Press.**

**Notes:**

You can also press: **Intr** (see display) or *Intrusion* (Function key preprogrammed by you).

*France and Sweden, press 8*

Before the Intrusion is executed a warning tone is sent to the parties in the ongoing call. A three party call is established and a warning tone is heard.

**Note:** *The warning tone might be disabled for your system. The Intrusion function might be blocked for use on your extension (programmed by your system administrator). If Intrusion is not allowed you will continue to receive a busy tone.*

**Bypass**

If this function is allowed from your extension, you can bypass an; activated Diversion, activated Follow-me or activated Absence Information on a specific extension.

**\* 6 0 \*** 

**Dial and enter the extension number.**

**#** **Press and wait for answer.**

## Speed Dialing

### Common Speed Dialing numbers

By using common Speed Dialing numbers, you can make calls simply by pressing a few keys. The common Speed Dialing numbers consist of 1–5 digits and are stored in the exchange (by your system administrator).



**Lift the handset and dial the common Speed Dialing number.**

### Individual Speed Dialing numbers

You can program up to ten frequently used phone numbers on the digit keys 0–9 and use them as individual Speed Dialing numbers (if this function is allowed).

**Note:** In Finland, up to nine numbers, keys 1–9.

To use:

**\* \* (0 – 9)**

**Dial and press the relevant digit.**

**Note:** Finland, dial \* \* (1 – 9); Sweden, dial (0 – 9) #.

To program and alter individual Speed Dialing numbers:

**\* 5 1 \* (0 – 9)**

**Dial and press the selected digit.**

**Note:** Finland, dial \* 5 1 \* (1 – 9).



**Press and dial the phone number.**



**Press.**

**Note:** The programmed number may consist of a maximum of 20 digits plus \*, which indicates the second dial tone from the public network.

**# 5 1 \* ( 0 - 9 )**

To erase one programmed number:

**Dial and press the selected digit.****Note:** *Finland, dial # 5 1 \* ( 1 - 9 )***Press.**

To erase all programmed numbers:

**# 5 1 #****Dial.****Press.****Dial by a Function key**

Both functions and phone numbers can be programmed on a Function key. To program a key, see section "[Programming of Function keys](#)" on page 77.

*Head office***Press the Function key.**

This Function key is preprogrammed by you.

**Dial-by-name (optional)**

By use of the Integrated Telephone Directory you can search for a name, group, operator, etc. via your display and then call the wanted person or group by use of a menu Function key below the display.

Dir

**Press (see display).**

The display shows:

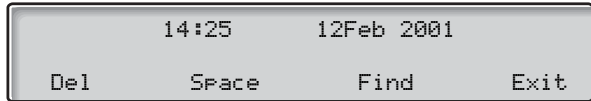

Del

**Press to delete the last entered character (see display).**

Space

**Press to enter a space (see display).**

Find

**Press to search using the entered characters (see display).**

Exit

**Press to return to the previous menu (see display).**

Use the key pad to enter the characters of the name. The characters above the keys show the key to be pressed.

*Example:*

Select characters by pressing digits repeatedly. The cursor is moved automatically when you stop pressing.



**Press a digit.**

1 time	result	A
2 times	result	B
3 times	result	C

When the requested character is shown on the display, wait for the cursor to move to the next place.

The name must be entered as follows:

**Family name - Space - Name.**

It is not necessary to enter all the characters, just as many to get as close as possible to the requested name when you start to search.

**Note:** *If you want to specify the person's first name, you must enter the full family name before you can enter a space.*



*Example:*

To search for Bob Smith:

**7 7 7 7**

**Press for S**

**6**

**Press for M**

**4 4 4**

**Press for I**

The display shows:

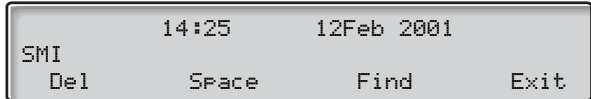

Find

**Press to find (see display).**

If SMI was sufficient to find Bob Smith, the display shows:



If SMI gives a name close to Bob Smith, e.g. Ann Smith, scroll down until you find the requested name.

Up

**Press to scroll up trough the name list (see display).**

Down

**Press to scroll down trough the name list (see display).**

Call

**Press to dial the number displayed (see display).**

Back

**Press to return to the previous menu (see display).**

If there is additional information in the directory for the name being displayed, this is shown under the name, e.g. company, country, etc.

The display will inform if no name matches your search and show the name alphabetically preceding the entered one.

## Authority

### Data privacy

Data privacy allows you to make a call without any disturbances, i.e. Intrusion. This function is automatically cancelled when the call is finished.



To order:

**Lift the handset.**

**\*41#** 

**Dial and enter the number.**

**Authorization Code, common (optional)**

If you are assigned to use a common Authorization Code (1 to 7 digits) you can temporarily change any used phone within the exchange to the authority level connected to this code. You can use the code for one call only or you can open the phone to some calls and lock it when leaving the phone.

To use for a single call:

**\* 7 2 \***

**Dial.**

⓪⓪⓪⓪  
⓪⓪⓪⓪  
⓪⓪⓪⓪  
⓪

**#**

**Enter Authorization Code and press.**

Verification tone.

**Note:** You can also press **AutCo** (see display), enter the code and press **Enter** (see display).

⓪⓪⓪⓪  
⓪⓪⓪⓪  
⓪⓪⓪⓪  
⓪

**Dial the digit or digits to get an external line and the external number.**

To open an extension for some calls:

**# 7 3 \***

**Dial.**

⓪⓪⓪⓪  
⓪⓪⓪⓪  
⓪⓪⓪⓪  
⓪

**#**

**Enter Authorization Code and press.**

Verification tone.

**Note:** You can also press **Open** (see display), enter the code and press **Enter** (see display).

To lock an extension:

**\* 7 3 \***

**Dial.**

⓪⓪⓪⓪  
⓪⓪⓪⓪  
⓪⓪⓪⓪  
⓪

**#**

**Enter Authorization Code and press.**

Verification tone.

**Note:** You can also press **Lock** (see display), enter the code and press **Enter** (see display).

**Authorization Code, individual (optional)**

If you are assigned to an individual Authorization Code (1 to 7 digits, affiliated to your own extension) you can lock your own extension to a common authority level, e.g. when out of the office. You can also temporarily change any other used phone within the exchange to the same authority level as you have on your own phone. The individual code can be changed from your own extension.

To lock your phone:

**\* 7 6 \***

**Dial.**

○○○  
○○○  
○○○  
○ #

**Enter Authorization Code and press.**

Verification tone.

**Note:** You can also press **Lock** (see display), enter the code and press **Enter** (see display).

To make calls with your authority level when your phone is locked:

**\* 7 5 \***

**Dial.**

○○○  
○○○  
○○○  
○ #

**Enter Authorization Code and press.**

Verification tone.

**Note:** You can also press **Auto** (see display), enter the code and press **Enter** (see display).

○○○  
○○○  
○○○  
○

**Dial the digit or digits to get an external line and the external number.**

To open your phone:

**# 7 6 \***

**Dial.**

○○○  
○○○  
○○○  
○ #

**Enter Authorization Code and press.**

Verification tone.

**Note:** You can also press **Open** (see display), enter the code and press **Enter** (see display).

To assign your own authority level to another phone:

**\*75\***

**Dial.**

⓪⓪⓪  
⓪⓪⓪ \*  
⓪

**Enter Authorization Code and press.**

Verification tone.

**Note:** You can also press **AutCo** (see display), enter the code and press **Enter** (see display).

⓪⓪⓪  
⓪⓪⓪ #  
⓪

**Dial your own extension number and press.**

Verification tone.

⓪⓪⓪  
⓪⓪⓪  
⓪

**Dial the digit or digits to get an external line and the external number.**

To change your individual Authorization Code:

**\*74\***

**Dial.**

⓪⓪⓪  
⓪⓪⓪ \*  
⓪

**Enter old Authorization Code and press.**

⓪⓪⓪  
⓪⓪⓪ #  
⓪

**Enter new Authorization Code and press.**

Verification tone.

## During Calls

### Group Listening (loudspeaking)

This function lets other people in your room listen to your phone conversation. You speak in the handset while the other party's voice is heard on the loudspeaker.

During an ongoing conversation:



**Press to switch between loudspeaker and handset.**

When the key lamp is on, the other party's voice is heard on the loudspeaker.

**Note:** You can adjust the volume, See section "[Settings](#)" on page 77.

#### From loudspeaking to handsfree



**Replace the handset.**

Handsfree conversation.

#### From handsfree to loudspeaking

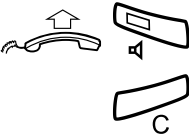

**Lift the handset and press.**

**Press to end the call.**

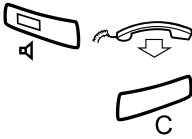

## Handsfree

**Press and replace the handset.**  
Handsfree conversation.

**Press to end the call.**



### From handsfree to handset

**Lift the handset.**  
Conversation via the handset.



## Mute

**Press to switch the microphone on or off.**

When the lamp is on, the person on the line cannot hear what is being said in your room.

## Inquiry

You have a voice connection on Line 1 and want to make an Inquiry to an internal or external party.



**Press.**

The first party is put on hold (Line 1 flashes slowly).

**Note:** *You can also press Line 2.*



**Call the third party.**

When the other party answers, you can switch between the calls (Refer Back), Transfer the call, create a Conference and end one of the calls.



**Press to end the Inquiry call.**

The third party is disconnected.



**Press to return to the first call.**

### Refer Back

The Line key lamp flashes for the call put on hold.

**Line 1** 

**Press to put third party on hold.**

First call is connected.

**Inquiry** 

**Press to put first call on hold.**

Third party is connected.

**Note:** You can also press Line 2 if you have initiated the Inquiry on Line 2.



**Press to terminate the connected call.**

---

## Transfer

You have an ongoing call and you want to transfer the call to another extension.

**Inquiry** 

**Press.**

**Note:** You can also press a free Line key.



**Call the third party.**

**Transfer** 

**Press before or after answer.**

The ongoing call is transferred.

**Note:** If you have put more than one call on hold, the last call that was put on hold will be transferred. If the dialed extension is busy or Transfer is not allowed, your phone will ring again.



## Conference

With this procedure you can include up to seven parties in a conference. Only the conference leader (i.e. the person initiating the conference) can admit participants. During the conference a tone will be heard every 15 seconds.

**Note:** *The conference tone might be disabled for your system.*

You have an ongoing conversation (Line 1) and want to establish a phone conference. You will become the conference leader.

**Inquiry** 

**Press.**

**Note:** *You can also press Line 2 or Inquiry.*



**Call the third party.**

Wait for answer.

**3**

**Press to establish a conference.**

**Note:** *You can also press: Conf (see display) or Conference (Function key preprogrammed by you).*

**Repeat the procedure to add more conference members.**



**Replace the handset to leave the conference.**

**Note:** *A tone burst is heard each time a participant enters or leaves the conference. When the conference leader leaves the conference, the conference will continue with the other included parties. The conversation is changed back to a normal two party connection when there is only two parties left.*

## On hold

You can temporarily put the ongoing call on hold. Calls put on hold can be resumed on your own or on another phone.



### Individual

**Press the ongoing call Line key and replace the handset.**

The key lamp flashes slowly.



**Press the flashing Line key again to resume the call.**

### Common

**8**

**Press.**

**Notes:**

You can also press: **Pick** (see display) or *On hold/Pick-up* (Function key preprogrammed by you).

France, press **4**; Sweden, press **6**

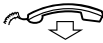

**Replace the handset.**

The key lamp flashes slowly. If your number is multiple represented on other phones, the key lamp that represents your number flashes slowly on these phones.

To resume the call on your own extension:



**Press the flashing Line key.**

To resume the call on another extension:



**Call the extension where the call was put on hold.**

**8**

**Press.**

**Notes:**

You can also press: **Pick** (see display) or *On hold/Pick-up* (Function key preprogrammed by you).

If your number is multiple represented on the phone, you can also press the key that represents your number.

France, press **4**; Sweden, press **6**

## Send Caller Identity Code at transfer

When transferring a call you can send the caller's Identity Code or number to the receiver's display.

You have a voice connection with an external party on Line 1.

**Inquiry** 

**Press to put the call on hold.**

**Note:** *You can also press Line 2.*

**\*77\***

**Dial.**

 **#**

**Dial the caller's Identity Code or number and press.**



**Call the second party.**

**Transfer** 

**Press before or after answer.**

The ongoing call is transferred with the caller's Identity Code or number.

**Note:** *You can only use this function if the receiver's phone is programmed to handle Identity Codes. This function is only available in newer versions of the telephone exchange.*

## Dialing during a connected call

When calling interactive teleservices, e.g. telephone banks, you need to use Dual Tone Multi Frequency (DTMF) signals. If your exchange is not already programmed to automatically convert your entered digits into DTMF signals, you need to activate the function during the call.

During an ongoing call:

**9** 

**Press and dial the requested digits.**

Entered digits are transferred as DTMF signals.

**Notes:**

*You can also press **Tone** (see display).*

*Finland, press **1** and dial the required digits.*

# Call Metering

## Cost information

Cost information for your call can be shown in the local currency in the display.

	14:25	12Feb 2001	
Cost in £	3.25		2222
Tones		Cost	Time

Cost

**Press to display or hide the cost indication (see display).**

**Note:** *The cost indication is automatically displayed for all charged calls, when the function is activated.*

## Call Duration

You can measure the elapsed time of your call. The feature can be activated when your phone is ready for dialing (internal dial tone is heard), during an outgoing call, or when you have a voice connection.

**Note:** System dependent, it can also be possible to activate Call Duration when your phone is idle.

Time

**Press to activate the Call Duration feature (see display).**

The display shows:

	14:25	00:00	
Start	Clr	Date	Exit 2222

Start

**Press to start time measurement (see display).**

The elapsed time is shown.

Clr

**Press to clear time measurement (see display).**

Date

**Press to show date (see display).**

Exit

**Press to exit the Call Duration feature (see display).**

Other key functions that are available during call duration mode:

Stop

**Press to stop time measurement (see display).**

Time

**Press to show time measurement (see display).**

# Call Forwarding

## Diversion

If you do not want to be disturbed or will be out of the office, you can have all calls to your extension diverted to a preprogrammed answering position. During Diversion you will hear a special dial tone and the Diversion lamp indicates that your Triple Access Line is diverted. You can still make calls as usual.

Diversion can be direct, on no answer, on busy or to another information service facility.

**Note:** *If your phone is programmed with "Multiple Directory Diversion and Do Not Disturb" (ask your system administrator), Diversion is ordered and cancelled simultaneously on all lines.*

### Order Direct Diversion from your own extension

The call is diverted to an individual position or up to three pre-determined common answering positions (depending on the type of the incoming call). Programmed by your system administrator.

**Note:** *Diversion can also be ordered and cancelled from the answering position, use the same procedure as in section "Internal Follow-me" on page 49.*

Diversion 

**Press.**

**Note:** *Function key preprogrammed by your system administrator. If you order Diversion with the handset off hook or the loudspeaker on, press the Diversion key twice. You can also use the procedure below.*

✳ 2 1 # 

**Dial and press.**

**Note:** *U.K., dial ✳ 2 #*

**Cancel Direct Diversion from your own extension**

**Note:** Diversion can also be ordered and cancelled from the answering position, use the same procedure as in section "[Internal Follow-me](#)" on page 49

Diversion 

**Press.**

**Note:** Function key preprogrammed by your system administrator. You can also use the procedure below.

**# 2 1 #**

**Dial.**

**Note:** U.K., dial **# 2 #**



**Press..**

**Diversion when there is no answer**

**\* 2 1 1 #**

**Dial to order.**

**Note:** Finland and Norway, dial **\* 6 1 #**



The incoming call is diverted after 3 signals.

**Press.**

**# 2 1 1 #**

**Dial to cancel.**

**Note:** Finland and Norway, dial **# 6 1 #**



**Press.**

**Diversion when caller receives a busy tone**

**\* 2 1 2 #**



**Dial to order.**

**Note:** *Finland and Norway, dial \* 6 7 #*

**Press.**

**# 2 1 2 #**



**Dial to cancel.**

**Note:** *Finland and Norway, dial # 6 7 #*

**Press.**

**Diversion to paging**

**\* 2 1 8 #**



**Dial to order.**

**Note:** *When Follow-me has been activated from your ordinary phone, you can re-divert calls to paging from the temporary answering position by adding \* and your extension number to the procedure, i.e. dial \* 2 1 8 \* your extension number # and press the Clear key. This function is only available in newer versions of the exchange.*

**Press.**

**# 2 1 8 #**



**Dial to cancel.**

**Press.**



## Internal Follow-me

All calls to your extension are diverted to another extension of your choice (within the private network). The Follow-me lamp indicates that you have activated Follow-me. During Follow-me, your phone can still be used for outgoing calls and you will hear a special dial tone when you lift the handset.

**Note:** If your phone is programmed with "Multiple Directory Diversion and Do Not Disturb" (ask your system administrator), Internal Follow-me is ordered and cancelled simultaneously on all lines.

### Order from your own extension



**Lift the handset.**



**Press and enter the answering position number.**

**Note:** Function key preprogrammed by your system administrator.

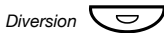

**Press to order.**



**Replace the handset.**

**Note:** You can also use the procedure below.

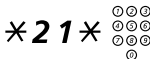

**Dial and enter the answering position number.**

**Note:** U.K., dial \* 2 \* No.

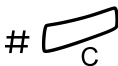

**Press.**

Diversion 

**Cancel from your own extension**

**Press.**

**Notes:**

*Function key preprogrammed by your system administrator.*

*You can also use the procedure below.*

# 2 1 # 

**Dial and press.**

**Note:** U.K., dial # 2 #

**Redirect from answering position**

If you move from one answering position to another answering position, you can redirect Follow-me from that new position.

**Note:** *Internal Follow-me must be ordered from your own extension before you can redirect from answering position.*

\* 2 1 \* 

**Dial and enter your own extension number.**

**Note:** U.K., dial \* 2 \* No.

\* 

**Press and enter the Diversion number.**

# 

**Press to redirect.**

*Calls are diverted to the answering position.*

**Cancel from answering position**

# 2 1 \* 

**Dial and enter your own extension number.**

**Note:** U.K., dial # 2 \* No.

# 

**Press.**

## External Follow-me

If external Follow-me is allowed you can have all calls to your extension diverted to an external number of your choice. The Follow-me lamp indicates that you have activated Follow-me. During Follow-me, your phone can still be used for outgoing calls and you will hear a special dial tone when you lift the handset.

\*22# 



### Order

**Dial and enter the digit or digits to get an external line and enter the external number.**

**Press.**

Diversion 

### Cancel

**Press.**

**Note:** Function key preprogrammed by your system administrator. You can also use the procedure below.

#22#



**Dial.**

**Press.**

## Personal Number (optional)

With this function you can be reached on your normal office phone number even if you are in another room, out of the office or at home, etc.

Depending on the functionality of your office exchange, you can have either one individual single search profile or you can choose between five individual search profiles.

A search profile can be designed to fit the situation, i.e. in the office, traveling, at home, etc. Both internal or external phone numbers can be used in a profile.

At your request, the search profiles are programmed or modified by your system administrator. See section "[To design and order your search profiles](#)" on page 54.

When the function is activated, incoming calls are transferred to different phones or to back-up services in the order you choose. If an answering position in the profile is busy, the call can be transferred to another predefined position in the profile, i.e. Voice Mail or a colleague. You can activate the function from your own office phone or when out of the office, by using the Direct Inward System Access function (DISA).

### To activate or change to another profile from your office phone

✳ 1 0 ✳

( 1 – 5 )

#  C

**Dial.**

**Press the search profile digit.**

**Press.**

The display shows the chosen search profile digit.

#### **Notes:**

*You can also activate and change to another profile by programming one Function key/search profile (the Function keys has to be pre-assigned by your system administrator). When the search profile is active the key lamp is on. See section "[Settings](#)" on page 77.*

*When another party is included in the activated profile, a colleague or an operator, etc., always remember to inform about your absence. If Voice Mail is included in the activated profile, always update your greeting with Absence Information.*

# 1 0 #



**To cancel from your office phone**

**Dial.**

**Press.**

**Note:** If you have activated a profile via a Function key, you can press this key instead of using the procedure above.

**To activate or change to another profile from an external phone**

The external phone must be of push button type provided with pound key (#) and star key (\*) or a mobile phone adapted for dial tone pulses (DTMF).



**Call the DISA function at your office.**

Dial tone.

\* 7 5 \*

**Dial.**



**Enter the Authorization Code and press.**



**Dial your own extension number and press.**

Dial tone.

\* 1 0 \*

**Dial.**



**Dial your own extension number and press.**

( 1 - 5 )

**Press the search profile digit.**



**Press and replace the handset.**

**Note:** When another party is included in the activated profile, a colleague or an operator, etc., always remember to inform about your absence. If Voice Mail is included in the activated profile, always update your greeting with Absence Information.

### To cancel from an external phone

The external phone must be of push button type provided with pound key (#) and star key (\*) or a mobile phone adapted for dial tone pulses (DTMF).



**Call the DISA function at your office.**

Dial tone.

**\* 7 5 \***

**Dial.**



**\***

**Dial the Authorization Code and press.**



**#**

**Dial your own extension number and press.**

Dial tone.

**# 1 0 \***

**Dial.**



**#**

**Dial your own extension number and press.**



**Replace the handset.**

### To design and order your search profiles

The search profiles are installed or changed by your system administrator. In order to set up your profiles, copy the setting form, fill in your new or changed profiles and give it to your system administrator.

**Note:** *If a profile handling application is connected to your system, you can edit profiles via your Intranet. See separate instructions for the application.*

Important notes when designing your search profiles:

- Avoid ring times longer than 45 seconds for your profiles.  
Usually the caller hangs up after 3-6 ring signals. If you need a longer ring time, the maximum time is 60 sec.
- Consider the time you need to react and answer on each answering position in your profile.  
You might need up to 15 seconds to react and answer a call on a desk or cordless phone and 20–25 seconds for a mobile phone.
- There must be an answering position at the end of every profile (Voice Mail or operator/secretary).  
If not, calls might end up unanswered.
- Consider what should happen while you are busy on a phone.  
The available options are:
  - *Activate Free on 2nd (if available)*
  - *Diversion to Voice Mail*
  - *Diversion to the operator*
- If an answering machine, a fax or other answering device is used as an early answering position, it might interrupt the searching.  
Disconnect the answering device, or design the ring times so they do not affect the searching.
- If your system admits just one single personal profile, design the profile only with your 2–3 most frequently used positions.  
If you add more numbers, there is a risk that the caller hangs up before a latter position is called.
- If your system admits 1–5 personal profiles, design the different profiles to fit your most frequently used positions.  
Make sure you use as few answering positions as possible for each profile. Profile examples:
  - *In office*
  - *At home*
  - *Traveling*
  - *Absent/not reachable*

*Example:*

How to fill in your setting form for search profiles:

**Profile 1 In office**

Search order	Type of telephone or Answering position*	Telephone number	Ring time (seconds)
1	Desk	1234	10
2	Cordless	5234	15
3	Voice Mail		

\* Examples: Desk, Cordless, Mobile, External, Voice Mail, Operator, etc.

**Profile 2 At home**

Search order	Type of telephone or Answering position*	Telephone number	Ring time (seconds)
1	External	222222	20
2	Mobile	0706666666	25
3	Voice Mail		



## Setting form for search profiles

Name:

Department:

Telephone No:

Account:

### Profile 1

.....

Search order	Type of telephone or Answering position*	Telephone number	Ring time (seconds)
1			
2			
3			
4			

\* Examples: Desk, Cordless, Mobile, External, Voice Mail, Operator, etc.

### Profile 2

.....

Search order	Type of telephone or Answering position*	Telephone number	Ring time (seconds)
1			
2			
3			
4			

### Profile 3

.....

Search order	Type of telephone or Answering position*	Telephone number	Ring time (seconds)
1			
2			
3			
4			

### Profile 4

.....

Search order	Type of telephone or Answering position*	Telephone number	Ring time (seconds)
1			
2			
3			
4			

### Profile 5

.....

Search order	Type of telephone or Answering position*	Telephone number	Ring time (seconds)
1			
2			
3			
4			

## Absence Information (optional)

Absence Information is used to inform callers why you are absent and when you return. If you are authorized, you can also enter Absence Information for another extension from your extension. During Absence Information, your phone can still be used for outgoing calls and you will hear a special dial tone when you lift the handset.

### Order

*Example: Back on September 15 (=0915).*

**\* 2 3 \***

**Dial.**

**( 0 – 9 )**

**Enter the absence code.**

**Note:** *The absence codes consist of one digit which depends on the system connected to the exchange. Contact your system administrator regarding the available absence codes.*

**\* 0 9 1 5**

**Press and enter the date (MMDD) or time (HHMM) of your return.**

**Notes:**

*If no return time or date is needed, this step can be skipped.*

*The order in which the date is stated is system dependent.*

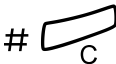

**Press.**

The display shows the reason, and if entered, time or date of return.

**# 2 3 #** Cancel



**Dial.**

**Press.**

The programmed information is erased.

Order for another extension

**\* 2 3 0 \***



**Dial.**

**Dial the extension number and press.**

**( 0 - 9 )**

**Enter the absence code.**

**\* 0 9 1 5**

**Press and enter the date or time of the other person's return.**



**Press.**

The display on the other person's extension shows the reason, and if entered, time or date of return.

Cancel for another extension

**# 2 3 0 \***



**Dial.**

**Dial the extension number and press.**

**Note:** If the special dial tone is received, the Authorization Code for the other extension is required. Add the code and press # before pressing the Clear key.



**Press.**

# Messages

## Manual Message Waiting (MMW)

If the called extension does not answer you can initiate a message waiting indication on that extension (if this function is allowed). If there is a message waiting, the Message key lamp is on and you will hear a special dial tone after lifting the handset.



### Answer

**Press.**

**Note:** Function key preprogrammed by your system administrator.

A call is initiated to the extension that requested Message Waiting.

### Checking the party that requested MMW



**Press.**

The program key lamp turns on and all other lamps turn off.



**Press.**

**Note:** Function key preprogrammed by your system administrator.

The number that requested Message Waiting is shown in the display.



**Press to finish procedure.**

Cancel MMW at your own extension

# 3 1 #

Dial.



Press.

Order MMW to another extension

\* 3 1 \*

Dial.



Dial the extension number.



Press.

The Message Waiting key lights up on the called extension.

Cancel MMW to another extension

# 3 1 \*

Dial.



Dial the extension number.

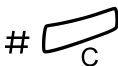

Press.

## Message Waiting (optional)

If assigned this function and your phone is diverted to an interception computer, a Function key (programmed by your system administrator) will flash when there are messages stored for you in the computer. The messages will be printed out on a printer connected to the computer.

Message 

### To print out messages

**Press.**

**Note:** *Function key preprogrammed by your system administrator.*

The display shows the identity of the computer and the number of messages stored for you.

If you find that the notification of Message Waiting is intrusive or you want to shut off the notification:

**# 9 1 # \***

**Dial.**

Acknowledgement tone.

## Voice Mail (optional)

This integrated Voice Mail function allows you to leave a voice message to the caller when you are unable to answer calls, e.g. when out of office, in a meeting, etc. The caller can then leave a message in your mailbox. When back in office you can enter your mailbox and listen to the messages received.

You can choose to divert all incoming calls to your mailbox, or calls when there is no answer, or calls when your phone is busy.

If you use the Personal Number function, it is recommended to program Voice Mail as the last answering position for all search profiles.

When you enter your mailbox, you will hear recorded instructions on how to handle listening, recording, storing and deleting messages, and how to change your security code.

### **To activate and deactivate your mailbox**

*For all incoming calls:*

See “[Diversion](#)” on page 46 (function code 21). Use the number to the Voice Mail system as the “answering position number”.

*When incoming calls get no answer:*

See “[Diversion](#)” on page 46 when there is no answer (function code 211).

*When incoming calls get a busy tone:*

See “[Diversion](#)” on page 46 when caller receives a busy tone (function code 212).

**To enter your mailbox**

From your office phone:



**Dial the number to the Voice Mail system.**

*Note: If a Function key is programmed for your mailbox and the key lamp is on or flashing (= a new message is received), you can also press this key.*

If you are asked to enter your security code:



**Enter your security code.**

Code at delivery = your extension number.

From another phone:



**Dial the number to the Voice Mail system.**

If you are asked to enter your security code (the used phone has a mailbox of its own):

**#**

**Press.**



**Dial your mailbox number.**

(normally your office extension number)



**Enter your security code (if required).**

**To enter someone else's mailbox**

**Dial the number to the Voice Mail system.**

If you are asked to enter your security code (the used phone has a mailbox of its own):

**#**

**Press.**



**Dial the mailbox number.**

(normally the office extension number of the other person)



**Enter the security code of the other person (if required).**



**To handle the mailbox**

Recorded information on the line tells you the number of new and stored messages. If you have too many messages stored, you will first be asked to delete saved messages.

Recorded instructions ask you to press different digits in order to listen to callers' messages, record your own greetings, change your password or exit your mailbox, etc.

The following diagram gives an overview of the mailbox system and the digits to be used.

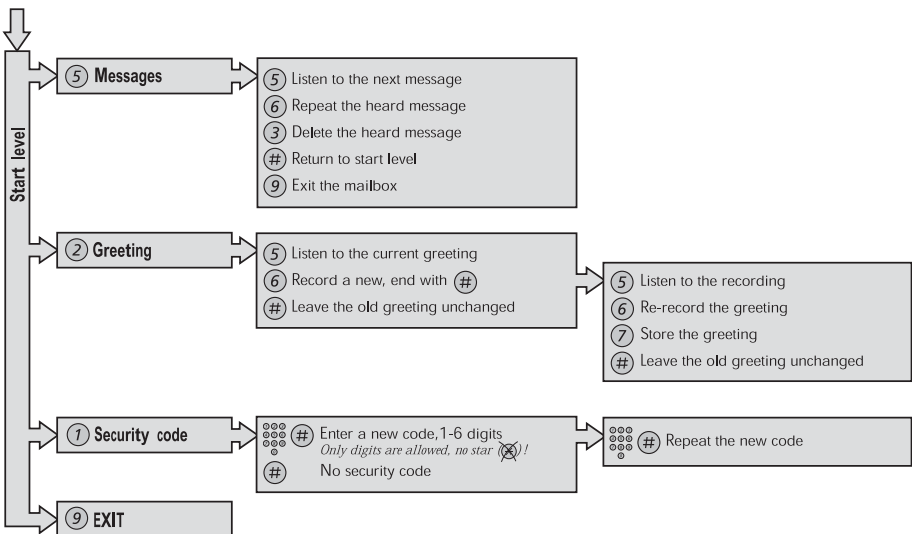

# Group Features

## Group Call-pick-up

People working in a team can have their phones programmed by their system administrator to form Call Pick-up groups.

In a Call Pick-up group, any member can answer any individual call to group members.

### **8** Press to answer.

**Notes:**

*You can also press **CUF** (see display).*

*One Call Pick-up group can serve as an alternative to another group. Calls to the alternative group can only be answered when there are no calls to your own group.*

*Finland and Sweden, press **0***

---

## Common Bell Group

Calls are signalled on a common bell.

### **8** Press to answer.

**Notes:**

*You can also press **CUF** (see display).*

*Finland and Sweden, press **0***

## Group Hunting

An internal Group Hunting number is a common directory number for a group of extensions. Calls to the group will be indicated at a free extension in the group.

When you leave the group temporarily, you make your phone unavailable for incoming calls.

\* 2 1 \*



# C

### To leave the group temporarily

**Dial and enter your own extension number.**

**Note:** U.K., dial \* 2 \* No.

**Press.**

# 2 1 #

C

### To re-enter the group

**Dial.**

**Note:** U.K., dial # 2 #

**Press.**

If you are authorized you can divert all calls to your group, to another extension or group:

\* 2 4 \*

**Dial.**

\*

**Dial the number of the group to be diverted and press.**

\*

**Dial the extension number of the new answering position.**

# C

**Press.**

# 2 4 \*

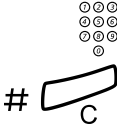

To cancel the Diversion:

**Dial.**

**Dial the number of the group that has been diverted.**

**Press.**

---

## Group Do Not Disturb

If your extension is defined as a master extension (programmed by your system administrator), you can mark a group of extensions as Group Do Not Disturb. The group can be bypassed by you.

\* 2 5 \*



To order:

**Dial and enter the group number.**

**Note:** *Germany and South Africa, dial \* 2 8 \* No.*

**Press.**

Special dial tone.

**Press.**

To cancel:

# 2 5 \*

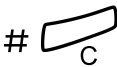

**Dial and enter the group number.**

**Note:** *Germany and South Africa, dial # 2 8 \* No.*

**Press.**

To bypass:

\* 6 0 \*

#

**Dial and enter the extension number.**

**Press.**

The call is made to the specified extension in the group.

## Other Useful Features

### Account Code (optional)

This function is used to charge a call to an account number or to prevent unauthorised calls from your phone. The Account Code can have 1 to 15 digits.

**\* 6 1 \***

**Dial.**

**Note:** *Finland and Norway, dial \* 7 1 \**

⊙ ⊙ ⊙ ⊙  
⊙ ⊙ ⊙ ⊙ #  
⊙ ⊙ ⊙ ⊙  
⊙

**Dial the Account Code and press.**

Dial tone.

**Note:** *You can also press **AcCo** (see display), enter the Account Code and press **Enter** (see display).*

⊙ ⊙ ⊙  
⊙ ⊙ ⊙  
⊙ ⊙ ⊙  
⊙

**Dial the digit or digits to get an external line and the external number.**

### Ongoing external call

When used to charge a call it is also possible to connect an ongoing external call to an Account Code. During the call:

**Line** 

**Press the ongoing call Line key to put the call on hold.**

**\* 6 1 \***

**Dial.**

**Note:** *Finland and Norway, dial \* 7 1 \**

⊙ ⊙ ⊙ ⊙  
⊙ ⊙ ⊙ ⊙ #  
⊙ ⊙ ⊙ ⊙  
⊙

**Dial the Account Code and press.**

Dial tone.

**Note:** *You can also press **AcCo** (see display), enter the Account Code and press **Enter** (see display).*

**Line** 

**Press the flashing Line key for the call put on hold.**

## Immediate Speech Connection

You automatically answer a call without lifting the handset or pressing any keys. The function can be permanently active or activated by use of a Function key (programmed by your system administrator).

### Permanently active

Program the ringing option with “Immediate Speech Connection with one ring signal”, option 6, on the Line key. See section “[Settings](#)” on page 77.

### Activated on a Function key

Automatic answer



**Press to order or cancel.**

**Note:** *Function key preprogrammed by your system administrator.*

The incoming call is signalled with one ring signal. When the key lamp is on you can use this function.

## General Deactivation

The following features can be simultaneously cancelled:

- Callback (all Callbacks are cancelled).
- Diversion/Internal and External Follow-me.
- Manual Message Waiting/Message Diversion.
- Do Not Disturb.

# 001 #



### Order

Dial.

Press.

---

## Night Service

When the exchange is in Night Service mode, all your incoming calls to the operator are transferred to a selected extension or group of extensions. The exchange is equipped with three different Night Service modes:

### Common Night Service

All incoming calls to the operator are transferred to one specific extension. Answer the call in the normal way.

### Individual Night Service

Selected external calls to the operator are transferred to one specific extension. Answer the call in the normal way.

### Universal Night Service

All incoming calls to the operator are transferred to a universal signalling device, e.g. the common bell. Answer the call as described in section “[Common Bell Group](#)” on page 66.

## Hot Line

This function is programmed by your system administrator.

### Delayed Hot Line

When the handset of the delayed Hot Line phone is lifted or when the Line key is pressed, a timer is started. If no digit is pressed before time out, a call is automatically generated to a specific extension or external line. If a digit is pressed before time out the phone works as an ordinary phone.

**Note:** *This function is only available in newer versions of the telephone exchange.*

### Direct Hot Line

The same function as described above, but without a delay. Only Hot Line calls can be placed from this line. To be used e.g. as alarm phone, door phone etc.

---

## Alarm Extension

An extension can be programmed by your system administrator as an Alarm Extension. A call to an Alarm Extension obtains automatic Intrusion if the extension is busy. Up to seven calling parties may be connected at the same time.

---

## Emergency mode

In the event of an emergency, the operator can set the exchange into Emergency mode, during which only preprogrammed extensions are permitted to make calls. If your extension is not assigned with this category and you try to make a call, you will not receive a dial tone.



## Data communication

Your phone can be used together with a PC as an integrated voice and data terminal. Contact your system administrator if you require this function.

---

## Additional Directory Number

You can be assigned (programmed by your system administrator) one or more Additional Directory Numbers (lines) on free Function keys.

To answer, make calls and use functions on the additional directory lines, use the same procedure as for the Triple Access Lines if nothing else is stated. However, you have to press the additional Line key after lifting the handset.

*Example:*

To make a call on an additional directory line:

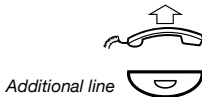

**Lift the handset.**

**Press.**

**Note:** *Function key preprogrammed by your system administrator.*



**Dial the extension number.**

## Multiple Represented Directory Number

Your extension number can be programmed on a dedicated key on other system telephones, i.e. your number is “represented” on these phones. Other extension numbers can of course also be “represented” on your phone.

**Note:** *This function has to be programmed by your system administrator.*

How multiple represented calls are handled depends on the programming of the phone, please contact your system administrator regarding this. In general the following applies:

### Incoming calls

Incoming calls can be answered (indicated with a flashing key lamp, calling party information and/or ring signal) on all phones where the number is represented.

### Outgoing calls

The dedicated key can be used to call the programmed extension.

---

## Malicious Call Tracing

If you are disturbed by bothersome or malicious external incoming calls, you can request number tracing from the network provider.

You can invoke tracing during or after an ongoing conversation. The external line can be held for a limited period of time.

### Order

During an ongoing conversation:

**Mal**

**Press (see display).**

**Note:** *You can also press Mal. Call Tracing (Function key preprogrammed by your system administrator).*

The system acknowledges with different tones whether the tracing request was accepted or rejected.

## DISA = Direct Inward System Access (optional)

If you are assigned to use this function and you are working externally, you can call your office and get access to an external line in order to make business calls. The business call will be charged your office extension number or an account number. You will just be charged for the call to the office.

The external phone must be of push button type provided with pound key (#) and star key (\*) or a mobile phone adapted for dial tone pulses (DTMF).

After a completed DISA call you must hang up before a new DISA call can be made.

There are different procedures depending on the type of Authorization Code, or when an Account Code is used.

### With common Authorization Code



**Call the DISA function at your office.**

Dial tone.

**\* 7 2 \***

**Dial.**



**#**

**Dial the Authorization Code and press.**

Dial tone.



**Dial the external number.**

### With individual Authorization Code



**Call the DISA function at your office.**

Dial tone.

**\* 7 5 \***

**Dial.**



**\***

**Dial the Authorization Code and press.**



**#**

**Dial your own extension number and press.**

Dial tone.



**Dial the external number.**

## Name and Number Log (optional)

With this function all unanswered calls to your phone will be logged. By use of the menu Function keys under the display you can browse the log, make calls to logged numbers and delete logged numbers.

A Function key must be programmed by your system administrator. The key lamp is switched on and will flash when new unanswered calls have been logged, since last time the key was activated.

Your phone must be idle and unlocked to be able to browse the log.

Number log



### To browse the number log

**Press.**

**Note:** *Function key preprogrammed by your system administrator.*

The key lamp is switched off and the display shows the number of stored numbers, time, date, name and number of the last unanswered call:

New missed calls:2			
14:25	12Feb 2001	Bob Smith	5432
Next	Del	Call	Exit

**Note:** *In previous system versions, the display text New missed calls is replaced with Unanswered calls.*

Next

**Press to show the next logged number (see display).**

Del

**Press to delete the displayed number (see display).**

Call

**Press to call the displayed number (see display).**

Exit

**Press to exit (see display).**

# Settings

## Programming of Function keys

Frequently used functions and phone numbers can be programmed on the Function keys for easy access. When you want to use the function, just press the key. Certain functions must be preprogrammed by your system administrator. Both phone numbers and function codes can be programmed on a Function key.

### Program or change a function

**Program** 

**Press.**



**Press selected Function key.**

**Note:** If the key is already programmed, the number or function will be displayed.



**Enter phone number or a function code according to the list in section “Functions and required data”.**

**Note:** If a wrong number is entered, press the Clear key to erase it, and then enter the number again.



**Press the Function key again.**

**Program** 

**Press to finish programming.**

Remove the transparent cover and write the function name or phone number beside the key.

**Note:** To erase a programmed function, press the Clear key, instead of the phone number or function code, in the sequence above.

Use the DCM (Designation Card Manager) to make and print your own designation cards. DCM is included on the Enterprise Telephone Toolbox CD or it can be downloaded from:

<http://www.ericsson.com/enterprise/library/manuals.shtml>

For more information, please contact your Ericsson Enterprise certified sales partner.

**To verify and erase programmed number or function**

**Program** 

**Press.**

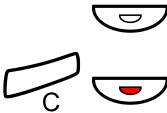

**Press selected Function key.**

The stored number or function is displayed.

**Press if you want to erase the stored number.**

The stored number is erased.

**Program** 

**Press.**

## Functions and required data

<i>Function</i>	<i>Function code or Associated number</i>			
	Most common	Finland	France	Sweden
Call pick up:				
Group	<b>8</b>		<b>4</b>	<b>6</b>
Individual	No. + <b>8</b>		No. + <b>4</b>	No. + <b>6</b>
Call Waiting	<b>5</b>	<b>6</b>	<b>6</b>	<b>4</b>
On hold, common	<b>8</b>		<b>4</b>	<b>6</b>
Conference	<b>3</b>			
Dial by a Function key	Extension No.			
Intrusion on busy extension	<b>4</b>		<b>8</b>	<b>8</b>
Last External Number Redial	<b>xxx</b>	<b>xx0</b>		<b>xx0</b>
Personal Number (list no.)	<b>(1-5)</b>			

Functions that need to be programmed by your system administrator:

- Additional lines
- Dedicated intercom link
- Do Not Disturb\*
- Free on 2nd
- Individual External Line
- Manual Message Waiting
- Name and Number Log
- Callback\*
- Diversion\*
- External line
- Immediate Speech Connection\*
- Malicious Call Tracing
- Multiple representation
- Search profile lists and pre-assigning of Function keys for Personal Number

*\*Function can be programmed by you.*

When the function is programmed *by you*, you *will not* get a toggle function. Instead you will have one key for activation and another key for deactivation. The key lamp will *not* indicate that the function is activated.

When the function is programmed *by your system administrator* you *will get* a toggle function and the key lamp will indicate that the function is activated.



## Programming of ring signals

You have 6 programmable ring signals on your phone. The different signals can be programmed on lines, additional lines and multiple represented lines.

**Program** 

**Line 1** 

**(0 – 6)**

**Press.**

**Press the corresponding Line key.**

A digit (0–6) is shown in the display.

**Select the ring signal you want to use according to the list below.**

- 0 = Silent.
- 1 = Periodic ring signal.
- 2 = Delayed periodic ring signal.
- 3 = One muted ring signal.
- 4 = One muted delayed ring signal.
- 5 = Immediate Speech Connection with one ring signal controlled by Function key.
- 6 = Immediate Speech Connection with one ring signal.

**Note:** *Options 5 and 6 are not available for multiple represented lines.*

**Line 1** 

**Press.**

**Program** 

**Press to finish programming.**

### To verify a ring signal

**Program** 

**Press.**

**Line 1** 

**Press the corresponding Line key.**

A digit (0–6) is shown in the display.

**Program** 

**Press to finish programming.**

## Programming of ring signal tone character

There are 10 different programmable ring signal tone characters on your phone, each corresponding to a digit between 0 and 9.

**Note:** *If you use melodies to signal incoming calls, this will replace the tone character. See section “Melody Ringing” on page 85.*

**Program** 

**( 0 – 9 )**

**Program** 

**Press.**

The current tone character is displayed.

**Press the corresponding digit.**

The phone rings with the chosen character.

**Press to finish programming.**

## Handset and loudspeaker volume

Use the Volume keys to change the volume of the handset or loudspeaker during a call. Adjust the handset listening volume when the handset is off hook. Adjust the loudspeaker volume when dial tone is heard via the loudspeaker, or during a handsfree call.



### Press to change the volume.

A volume symbol is shown for a few seconds (replacing your extension number). The handset and loudspeaker volume level is stored.

To adjust the volume during Group Listening:

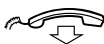

### Replace the handset.



### Press to change the volume.

A volume symbol is shown for a few seconds (replacing your extension number). The handset and loudspeaker volume level is stored.



### Lift the handset and press.

For people with impaired hearing, the handset hearing volume level can be extra amplified. To change the level:

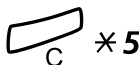

### Press simultaneously for at least 1 sec.

A tone signal is heard, and the display shows **Settings Mode**.



### Press to set or reset the volume level.

Key lamp on indicates amplified volume level. Key lamp off indicates default volume.



### Press to finish setting.

When extra amplification has been selected, the Line 1 key lamp turns off.

**Note:** A level change also effects a headset connected to the headset outlet.

## Ring signal volume



Use the Volume keys to adjust the ring signal volume when the phone is idle or ringing. Adjusted volume is stored.

### **Press to change the volume.**

A volume symbol is shown for a few seconds (replacing your extension number).

---

## Mute ring signal



You can suppress the ring signal for an incoming call.

### **Press to suppress the ring signal.**

The ring signal is switched off for the current call.

---

## Silent Ringing



If you do not want to be disturbed by the ring signal but still want to be able to answer an incoming call, you can switch off the ring signal. Incoming calls are only indicated by a flashing line lamp and display information.

### **Press to switch off the ring signal.**

The Mute key lamp is switched on to indicate Silent Ringing. The ring signal will automatically be switched on the next time you lift the handset or press any key.

## Melody Ringing

If you want to replace the ring signal with personal melodies when your phone rings, you can program one melody to signal an internal call, a second melody for an external call and a third melody to signal a Callback call.

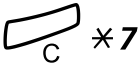

**Press and hold simultaneously to enter melody mode.**

Melody Mode

If there is a stored and activated melody for internal calls (Line 1), external calls (Line 2) or Callback calls (Inquiry), the corresponding key lamp is switched on.

In melody mode you can:

- Program new melodies
- Edit or delete stored melodies
- Activate or deactivate stored melodies

**#**

**Press to exit melody mode.**

**Note:** *If you do not press any key within 30 seconds, melody mode is automatically cancelled.*

**Program a new melody, edit or delete a current melody**

**Program** 

**Press.**

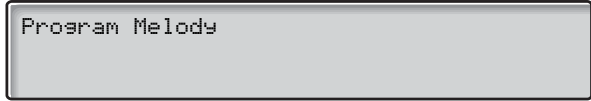

**Press the key for the requested type of call:**

If there is a current melody, the melody is played and the last 19 notes or signs are displayed.

**Line 1** 

**Press for internal calls,**

**or**

**Line 2** 

**press for external calls,**

**or**

**Inquiry** 

**press for Callback calls.**

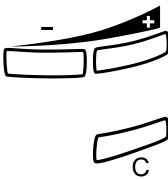

To edit the current melody:

**Press to move the cursor to the right of the position to be edited.**

Keep pressed to go to the beginning or to the end.

**Press to erase the note to the left of the cursor.**

Keep pressed to erase all the notes.

To enter a new melody or new notes, see section [“To enter notes”](#) on page 88.

To store the current melody:

**Line** 

**Press the flashing Line key (Line 1 or Line 2 or Inquiry).**

**Program** 

**Press.**

The current melody is stored.

**Note:** *The melody is not activated, see section [“Activate or deactivate a stored melody”](#) on page 87.*



To delete the current melody:

**Press and hold until no notes are displayed.**



**Press the flashing Line key (Line 1 or Line 2 or Inquiry).**



**Press.**

### Activate or deactivate a stored melody

A stored melody has to be activated in melody mode to be heard when you get an incoming call.

To activate (in melody mode):



**Press the key for the requested type of call (Line 1 or Line 2 or Inquiry).**

The corresponding key lamp is switched on:

Line 1 key = Internal calls

Line 2 key = External calls

Inquiry key = Callback calls

**Note:** *If you want to return to an ordinary ring signal but keep the melody stored, just press the key for the requested type of call again. When the key lamp is off the stored melody is deactivated.*



**Press to exit melody mode.**

1c 2d 3e  
 4f 5g 6a  
 7b 8+c 9+d

**To enter notes**

In melody mode, the key pad is used to enter notes, pauses, etc. A maximum of 40 notes can be programmed for incoming calls, and 20 notes for recalls.

This is how the keys are used:

**Press to insert notes (1–9).**

**Note:** A short press gives a short note, a long press gives a long tone (displayed by a capital letter), +c and +d means the higher octave.

✱

**Press to insert a short pause (p).**

Hold to get a long pause (P). Repeat to get a longer pause (pp...p).

0

**Press to get a higher octave for the inserted note.**

A + is shown in front of the note to indicate the higher octave.

Example: 30 to get +e

#

**Press to increase or decrease the pitch for the inserted note.**

Press once for sharp pitch, twice for flat pitch and three times to get the normal pitch.

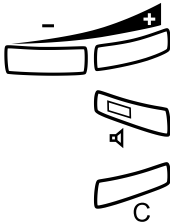

**Press to move the cursor to the left or to the right.**

Keep pressed to go to the beginning or to the end.

**Press to listen to the entered notes.**

**Press to erase the note to the left of the cursor.**

Keep pressed to erase all the notes.

Melody example:

James Bond theme programmed for internal calls:

C d d D D pp C C C C #d #d #D #D pp D D D ##A G pppp G F G

**Enter the notes.**

Grey digit = Long press.

1 2 2 2 2 ✱ ✱ 1 1 1  
 1 2 # 2 # 2 # 2 #  
 ✱ ✱ 2 2 2 6 # # 5  
 ✱ ✱ ✱ ✱ 5 4 5

**Note:** The # key (to get a sharp or flat tone) is pressed after the note, but is displayed before the note.



When the first 19 positions are entered, the display shows (only last entered 19 positions can be shown):

```
Program Intern
CddDDFFCCCC#d#d#D#D<
```

When all the notes are entered, the display shows (only last entered 19 positions are shown):

```
Program Intern
#D#DFFDDDbAGFFFFGFG<
```

**Note:** The flat A (##A) is shown as bA, i.e. b is used to show both the note b and the flat sign.

---

## Display contrast

You can adjust the contrast for the display.

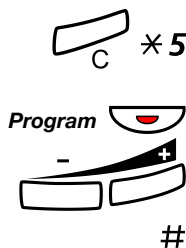

**Press and hold simultaneously until a ring signal is heard.**

The display shows `Setting Mode`.

**Press.**

**Press repeatedly to adjust the contrast.**

**Press to save and exit.**

**Note:** To exit the menu without saving the changes, press **#** before you press any of the adjustment keys.

# Accessories

## Key panel

Your phone can be equipped with additional key panels. Each key panel offers 17 additional keys for storing of your most frequently used telephone numbers and functions, and for supervising extensions.

Your telephone can be expanded with up to four key panels in newer versions of the exchange and up to two key panels in older versions of the exchange. If you do not know which version of the exchange you are using, ask your system administrator.

How to install the key panel, see section “[Installation](#)” on page 96.

**Notes:**

*All key panels must be of type DBY 419 01.*

*Depending on the system version, the Dialog 4223 Professional phone can be delivered with one key panel as standard.*

Use the DCM (Designation Card Manager) to make and print your own key panel designation cards. DCM is included on the Enterprise Telephone Toolbox CD or it can be downloaded from: <http://www.ericsson.com/enterprise/library/manuals.shtml>

For more information, please contact your Ericsson Enterprise certified sales partner.

## Headset (optional)

How to install the headset, see section “[Installation](#)” on page 96.  
The following headset functions are available.

### Answer calls



#### **Press to answer.**

The Headset key lamp is turned on.

**Note:** When the phone is set for Headset Preset, you can also press the flashing Line key to answer the call. See section “[Headset Preset](#)” on page 92.



#### **Press to terminate the headset call.**

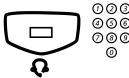

### Make calls

#### **Press and dial the number.**

The Headset key lamp is turned on.

**Note:** When the phone is set for Headset Preset, you can also dial the number directly without pressing the Headset key, or press a Line key instead of the Headset key. See section “[Headset Preset](#)” on page 92.



#### **Press to terminate the call.**



### From headset to handset

#### **Lift the handset.**

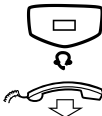

### From handset to headset

#### **Press.**

The Headset key lamp is turned on.

#### **Replace the handset.**



### Headset with Group Listening (loudspeaking)

#### **Press to toggle between headset with or without Group Listening.**

When the Loudspeaker key lamp is on, the Group Listening is active.



### From headset to handsfree

#### **Press.**

The Loudspeaker key lamp is turned on.



#### **Press.**

### From handsfree to headset

#### **Press.**

The Headset key lamp is turned on.



### Headset Preset

By default the phone is set for calls to be connected to the loudspeaker when you answer or make calls by pressing a Line key, so called **Loudspeaker Preset**. Also when you dial the number without lifting the handset, the call is automatically connected to the loudspeaker.

When you use a headset for your telephone, you can change the setting to get calls connected to the headset instead, so called **Headset Preset**. In Headset Preset mode you can make headset calls by pressing digits directly (direct dialing). You can also answer headset calls by pressing a Line key.

#### **Notes:**

*Independent the type of preset setting, when you lift the handset the call is always connected to the handset.*

*Also handsfree and loudspeaking work as usual, i.e. when the Loudspeaker key is pressed, the call is temporarily connected to the loudspeaker.*

*Activation and cancellation of Headset Preset can only be done when the telephone is in idle mode.*

To activate Headset Preset:



**Press and hold for at least 4 seconds.**

A short acknowledgement tone signal is heard, and **Headset Preset** is displayed for a few seconds.

To cancel Headset Preset:



**Press and hold for at least 4 seconds.**

A short acknowledgement tone signal is heard, and **Loudspeaker Preset** is displayed for a few seconds.

To check the current preset setting:

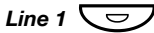

**Press.**

Either the Loudspeaker or Headset key lamp is turned on, indicating the current preset setting.



**Press.**

**Headset volume**

Use the Volume keys to change the volume of the headset.



**Press to change the volume.**

A volume symbol is shown for a few seconds (replacing your extension number). The set headset volume level is stored.

To adjust the volume for the loudspeaker of the phone during Group Listening:

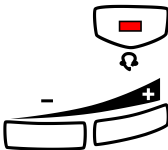

**Press.**

**Press to change the volume.**

A volume symbol is shown for a few seconds (replacing your extension number). The Loudspeaker volume level is stored.



**Press.**

For people with impaired hearing, the headset hearing volume level can be extra amplified, use the same procedure as described in section [“Handset and loudspeaker volume”](#) on page 83.

## Extra handset (optional)

The extra handset is used in parallel with the ordinary handset allowing another person to listen to an ongoing call. The extra handset is connected to the headset outlet under the phone, see section “[Installation](#)” on page 96.

It is possible to switch between the speaking party and the listening party.



**Press to switch between the speaking and listening party.**

**Note when speaking:** *Due to speech quality, only one person at the time shall speak.*

---

## Pull-out leaf (optional)

The pull-out leaf is used for a personal telephone number list and is installed under the phone. How to install the pull-out leaf, see section “[Installation](#)” on page 96.

Use the DCM (Designation Card Manager) to make and print your own card for the pull-out leaf. DCM is included on the Enterprise Telephone Toolbox CD or it can be downloaded from: <http://www.ericsson.com/enterprise/library/manuals.shtml>

For more information, please contact your Ericsson Enterprise certified sales partner.

## Option unit (optional)

The option unit DBY 420 01/1 is an optional accessory to be installed under your telephone set. The unit is used to connect either an extra bell outside your room, or a busy signal lamp outside your door.

### To check or set the option unit for extra bell or for busy signal

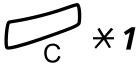

**Press and hold simultaneously until a ring signal is heard.**

The display shows **OPTION PROGRAMMING** and the Line 2 key lamp indicates the setting of the option unit:

Off=Extra bell, On=Busy signal lamp. Flashing=Combined extra bell & busy lamp.

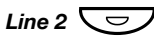

**Press to change to busy signal,**

or

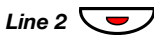

**press to change to extra bell & busy signal,**

or



**press to change to extra bell.**

**#**

**Press to save the setting and exit.**

**Note:** *If you do not press #, the phone automatically returns to idle about 30 seconds after the last key press.*

# Installation

## Install cables

Handset cable to the left

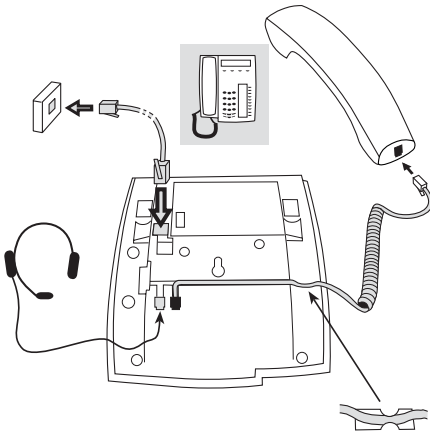

Handset cable to the right

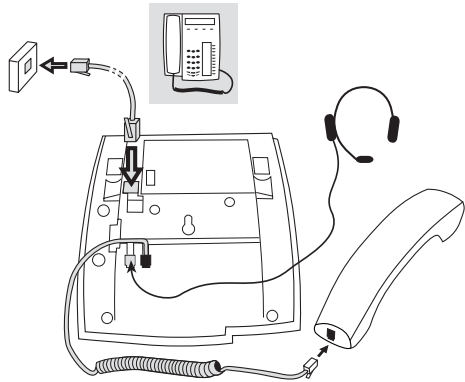

You can put the cable to the handset in the notch underneath the telephone. The cable to the exchange has to be plugged in “LINE” and the handset cable has to be plugged in “HANDSET”.

### **Change cables**

To remove a cable, use a screwdriver to unlock the stop.



## Install stands and adapt telephone

Position high

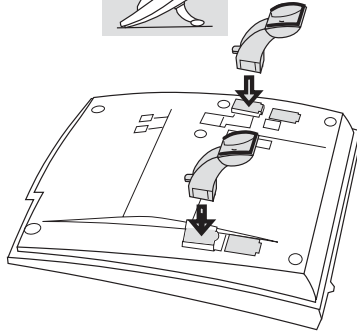

Position low

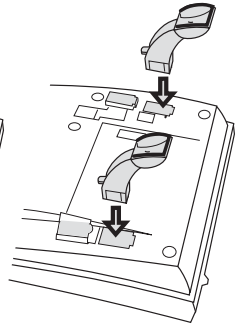

Press to fasten stand

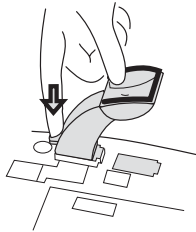

Release to remove stand

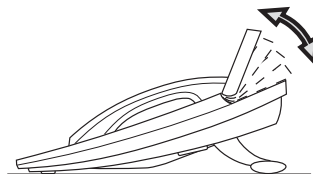
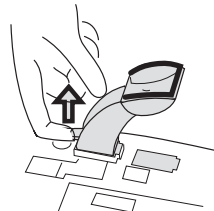

Tiltable display

Adjustable angle

## Install card

Use the DCM (Designation Card Manager) to make and print your own designation cards. DCM is included on the Enterprise Telephone Toolbox CD or it can be downloaded from: <http://www.ericsson.com/enterprise/library/manuals.shtml>

For more information, please contact your Ericsson Enterprise certified sales partner.



## Install key panels

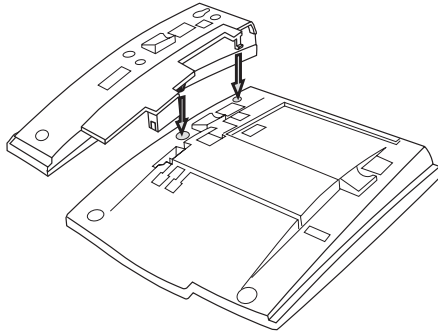

**1 Attach the key panel unit.**

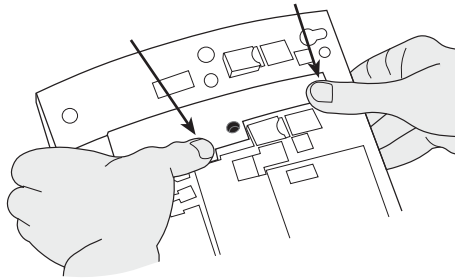

**2 Press hard where the arrows are pointing, until you hear the “Click” sound.**

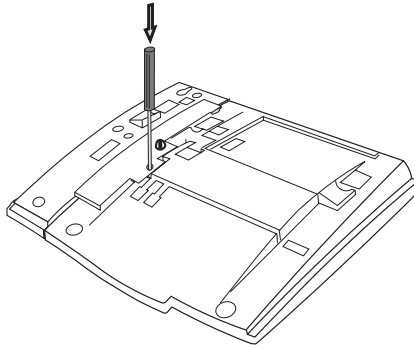

- 3 Use a screwdriver and press hard in the bottom of the hole, until you hear a weak sound.**
- 4 Install the stands as shown in picture “Stand positioning”.**

**Notes:**

*All key panels must be of type DBY 419 01.*

*Depending on the system version, the Dialog 4223 Professional phone can be delivered with one key panel as standard.*

**Stand positioning (1-4 key panels)**

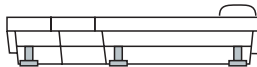
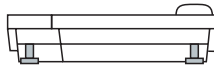

### **Install card**

Use the DCM (Designation Card Manager) to make and print your own key panel designation cards. DCM is included on the Enterprise Telephone Toolbox CD or it can be downloaded from: <http://www.ericsson.com/enterprise/library/manuals.shtml>

For more information, please contact your Ericsson Enterprise certified sales partner.

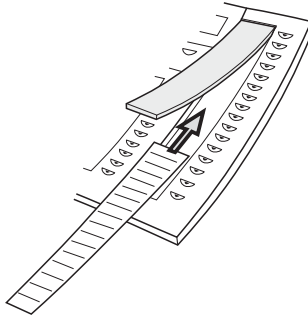

## Install pull-out leaf (optional)

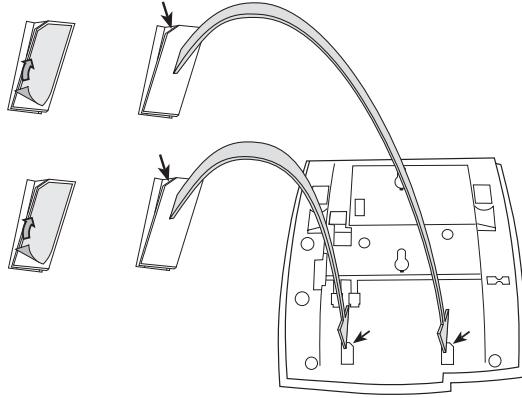

- 1 Remove the protective film from the guiding rails.**
- 2 Attach the guiding rails to the bottom of the phone, observing the direction of the "cut" corner.**

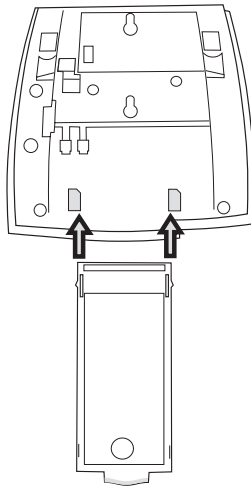

- 3 Insert the pull-out leaf.**

## Wall mounting

The phone can be wall mounted without using a special console. Useful for instance in conference rooms or public areas.

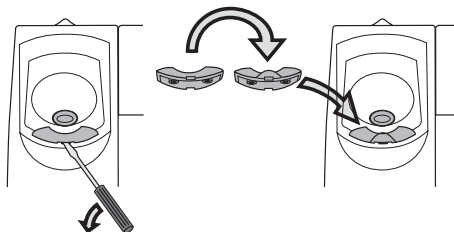

- 1 Use a screwdriver to remove the handset hook.**
- 2 Turn the hook upside down and insert.**

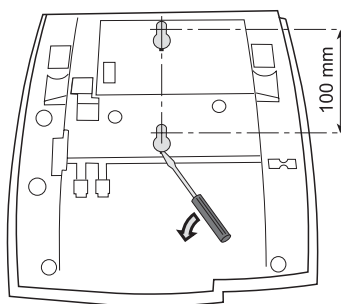

- 3 Use a screwdriver to remove the two plastic covers.**
- 4 Drill wall holes according to measure.**

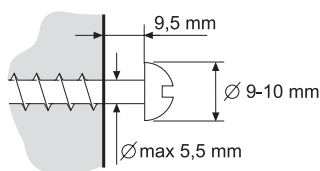

- 5 Mount screws according to measures and attach the phone.**

## Placing the phone

Do not expose your phone to direct sunlight for long periods. Keep the phone away from excessive heat and moisture.

---

## Cleaning

Clean your phone only with a soft, water dampened cloth. Using soap or any other cleaning materials may discolor or damage the phone.



# Troubleshooting

If your phone is out of order, you can initiate a telephone selftest to check whether there is a fault in the phone or in the system. You can also check the firmware revision state of your phone.

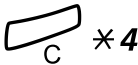

## To initiate a telephone selftest

**Press and hold simultaneously until a ring signal is heard.**

The display shows the firmware revision state and **Selftest OK** for a few seconds. If there is something wrong, a fault message appears. Inform your system administrator about the fault message.

All the key lamps on the phone (and connected extra key panel) should be switched on during the selftest to indicate that each key lamp is OK.

After a few seconds the display is checked (the display is completely dark). The display is OK when there are no light dot(s) or line(s). The light frame around the display is supposed to be there.

**#** **Press to exit.**

**Note:** *If you do not press #, the selftest is automatically finished after about 30 seconds.*

# Glossary

<b><i>Additional lines</i></b>	One or more additional extension numbers can be assigned to your phone, these are programmed on free Function keys.
<b><i>Exchange</i></b>	Switch. Your telephone switching system, e.g. MD110 Communication System.
<b><i>Idle display</i></b>	A message shown in the display when the phone is idle. This message is programmed by your system administrator.
<b><i>Idle mode</i></b>	The state your phone is in when nothing is activated; not calling, not ringing, not diverted etc.
<b><i>Speed Dialing number</i></b>	Abbreviated number or short number, used for making frequently used numbers faster to dial.
<b><i>Supervision</i></b>	Your extension number can be represented on a Function key on other extensions (two or more).
<b><i>Traffic state</i></b>	The different states your phone is in; calling, ringing, diverted, etc.
<b><i>Triple Access Line</i></b>	A collective name for Line 1, Line 2 and Inquiry lines. Line 1 and Line 2 forms your extension number and are available both for incoming and outgoing calls. Inquiry can only be used for outgoing calls.

# Index

## A

Absence information 58  
 Accessories 90  
   Extra handset 94  
   Headset 91  
   Key panel 90  
   Option unit 95  
   Pull-out leaf 94  
 Account Code 69  
 Additional Directory Number 73  
 Alarm Extension 72  
 Answer calls 18  
 Authority 34  
 Authorization Code, common 35  
 Authorization Code, individual 36

## B

Bypass 29

## C

Call Duration 45  
 Call Forwarding 46  
   Diversion 46  
   External Follow-me 51  
   Internal Follow-me 49  
   Personal Number 52  
 Call metering 44  
 Call Waiting 28  
 Callback 26  
 Common Bell Group 66  
 Common Speed Dialing numbers 30  
 Conference 41  
 Copyright 5  
 Cost information 44

## D

D3 mode information 9  
 Data communication 73

Data privacy 34

Declaration of conformity 5

Description 6

  Choice of language 16

  D3 mode information 9

  Display information 13

  Lamp indications 10

  Menu Function keys 15

  Tones and signals 11

Dial by a Function key 31

Dial-by-name 32

Dialing during a connected call 43

DISA = Direct Inward System Access 75

Display information 13

Diversion 46

Do Not Disturb, DND 21

DTMF signals 43

During calls 38

  Conference 41

  Dialing during a connected call 43

  Group Listening (loudspeaking) 38

  Handsfree 39

  Handsfree to loudspeaking 38

  Inquiry 39

  Loudspeaking to handsfree 38

  Microphone on or off 39

  On hold 42

  Send caller's Identity Code 43

  Transfer 40

## E

Emergency mode 72

External Follow-me 51

Extra handset 94

## F

Free on 2nd access 20

Free Seating 17

Functions and required data 79

## **G**

- General Deactivation 71
- Glossary 106
- Group Call-pick-up 66
- Group Do Not Disturb 68
- Group features 66
- Group Hunting 67
- Group Listening (loudspeaking) 38

## **H**

- Handset and loudspeaker volume 83
- Handsfree 39
- Headset 91
- Hot Line 72

## **I**

- Immediate Speech Connection 70
- Incoming calls 18
  - Answer a second call 20
  - Do Not Disturb, DND 21
  - Handsfree 18
  - On another extension 19
  - On any other line key 18
  - On Line 1 18
- Individual External Line 24
- Individual Speed Dialing numbers 30
- Inquiry 39
- Installation 96
- Internal Follow-me 49
- Internal messages 60
- Intrusion 28

## **K**

- Key panel 90

## **L**

- Lamp indications 10
- Language 16
- Last External Number Redial 24

## **M**

- Mailbox 65
- Make calls 22
- Malicious Call Tracing 74
- Manual Message Waiting (MMW) 60
- Melody Ringing 85
- Menu Function keys 15

- Message Waiting 62
- Messages 60
  - Manual Message Waiting (MMW) 60
  - Message Waiting 62
  - Voice Mail 63
- Multiple Represented Directory Number 74
- Mute 39
- Mute ring signal 84

## **N**

- Name and Number Log 76
- Night Service 71
- Number Presentation Restriction 23

## **O**

- On hold 42
- Option unit 95
- Other useful features 69
- Outgoing calls 22
  - Authority 34
  - Bypass 29
  - Call Waiting 28
  - Callback 26
  - External calls 22
  - Handsfree 23
  - Individual External Line 24
  - Internal calls 22
  - Intrusion 28
  - Last External Number Redial 24
  - Number Presentation Restriction 23
  - Save external number 25
  - Speed Dialing 30
  - When you receive a busy tone 26

## **P**

- Personal Number 52
- Programming of functions 77
- Programming of ring signal tone character 82
- Programming of ring signals 81
- Pull-out leaf 94
- Put a call on hold 42

## **R**

- Redial number 25
- Refer Back 40
- Ring signal volume 84
- Ring signals 12

**S**

- Save external number 25
- Send Caller Identity Code at transfer 43
- Setting form for search profiles 57
- Settings 77
  - Functions and required data 79
  - Handset and loudspeaker volume 83
  - Melody Ringing 85
  - Mute ring signal 84
  - Programming of functions 77
  - Programming of ring signal tone character 82
  - Programming of ring signals 81
  - Ring signal volume 84
  - Silent Ringing 84
- Short numbers 30
- Silent Ringing 84

Speed Dialing 30

**T**

- Tones and signals 11
- Transfer 40
- Troubleshooting 105

**V**

- Voice Mail 63
- Volume 83

**W**

- Warranty 5
- Welcome 4
- When you receive a busy tone 26

Ericsson is shaping the future of Mobile and Broadband Internet communications through its continuous technology leadership. Providing innovative solutions in more than 140 countries, Ericsson is helping to create the most powerful communication companies in the world.

Ericsson Enterprise AB  
All rights reserved.  
For questions regarding the product,  
please contact your Ericsson Enterprise Certified Sales Partner.  
Also visit us on <http://www.ericsson.com/enterprise>

© Ericsson Enterprise AB 2004  
EN/LZT 103 61 R2B